

Sensolute GmbH

Hermann-von-Helmholtz-Platz 1
D-76344 Eggenstein-Leopoldshafen

+49 (0) 721 608 25623
+49 (0) 721 608 29016

info@sensolute.com
www.sensolute.com

DATASHEET

Micro Vibration Sensor
MVS1006.01

Revision 2.0
Supersedes data of 2010 Dec. 07

2013 Mar. 25



MVS1006.01

FEATURES

- Unidirectional vibration sensor
- Wide supply voltage range: 1.80 V to 15 V
- Low operating current
(e.g. I_{cc} max. 0.2 μ A at V_{cc} 2V and R 10Meg)
(e.g. I_{cc} max. 2.0 μ A at V_{cc} 2V and R 1Meg)
- Noiseless
- $R_{On} < 100 \Omega$
- Protected against environmental stress
- Automated SMT-mounting
- RoHS compliant, lead free
- Specified from -20 °C to +70 °C
- Size 2.85 mm x 2.45 mm x 1.7 mm
- Reacting point: approx. 50 mg

APPLICATIONS

- Motion detection
- System wake up – low power

MATERIAL

Package: PCB laminate material
Inner contact material: Gold plated
Ball: Stainless steel, gold plated

DESCRIPTION

The micro vibration sensor is used for the detection of slight movements and vibrations by means of a mobile micro sphere. The ball bridges two contacts reducing the resistance between the two external connection pads from several mega ohms ($> 30 \text{ MOhm}$) to below 100 Ohms. The sensor is fully passive, requires no signal conditioning, and operates with currents as low as 0.2 μ A.

With the aid of tool-specific evaluation electronics, the micro vibration sensor controls the operation of movement-sensitive devices. The micro vibration sensor is utilised for converting many systems to environmentally friendly devices by implementing wake-up and power-down logic to conserve battery power and bringing energy consumption to a minimum, pushing the availability of green technology and green electronics into new areas of design and application.

The sensor is typically used for applications such as bike computers, remote controls, electronic lock systems, RFID transponders, GPS tracking systems, wireless sensor networks, illuminated dog`s collars, access control systems, data loggers, bicycle lights, that are only switched on when in motion.

Index

1. Operating Conditions.....	4
2. Soldering Process	4
3. Functionality	4
4. Qualification	5
5. Package mechanical data	6
5.1 Package outline.....	6
5.2 Footprint.....	6
6. Ordering information.....	7
6.1 Tape and reel (standard-packing).....	7
6.2 Tray (special-packing)	8
7. Important Notice	9

1. Operating Conditions

PARAMETER	SYMBOL	MIN	MAX	UNIT
Supply voltage	V_{CC}	+1.80	+15	Vdc
Current*	I_{CC}		2	mA
R Open	R_O	-	> 30	MOhm
R Closed	R_C	< 100	-	Ohm
Operating ambient temperature	T_{amb}	-20	+70	°C

* Current consumption is determined by the resistance of the application circuit and the supply voltage. The sensor is fully passive, requires no signal conditioning, and operates with currents as low as 0.2 μ A.
(e.g. max. I_{CC} 0.2 μ A at V_{CC} 2V and R 10Meg)
(e.g. max. I_{CC} 2.0 μ A at V_{CC} 2V and R 1Meg)

2. Soldering Process

Reflow Soldering Process 260°C, 10 sec

3. Functionality

A mobile, gilded micro sphere is located inside the hollow space of the sensor. When moving, the micro sphere bridges two gilded contacts by switching over from a high resistive to a low resistive state. When the Sensor is at rest between 90° - 0° - 270° it is **not necessarily closed**. Only in 70% - 99% of time the sensor will be closed when at rest. In a rest position between >90° - 180° - <270°, the sensor will be open to 100%.

The figure shows the typical characteristics of the sensor in excitation and rest.

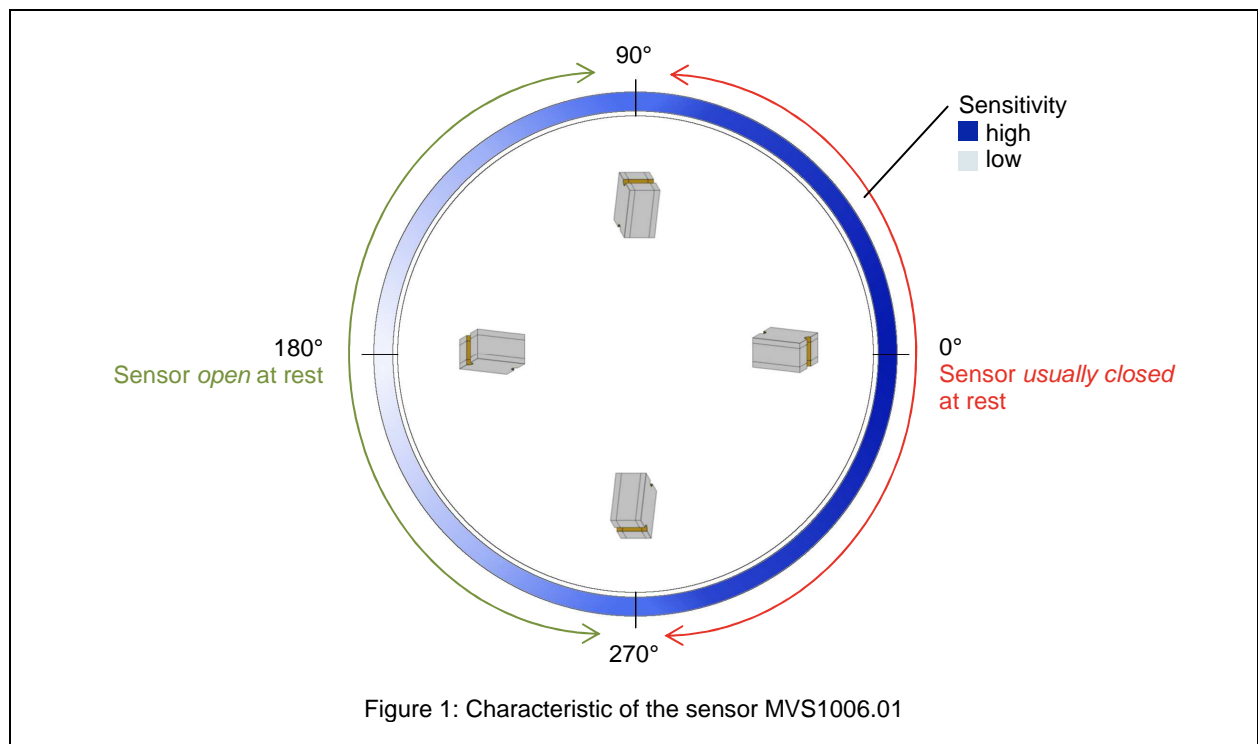

4. Qualification

High temperature and high humidity storage

Test time: 48h
 Test temperature: 50°C
 Humidity: 90%
 without condensation
 no evidence of internal corrosion after the test.

High humidity storage

Test time: 96 h
 Test temperature: 40°C
 Test humidity: 95%
 no evidence of internal corrosion after the test.
 no shape distortion

Temperature cycle storage

Test cycle: 8 cycles, T1 = 65°C for 6h, T2 = -20°C for 6h,
 temperature change rate = 3K/min
 no evidence of internal corrosion after the test.
 no shape distortion

Non Operation Half Sine Shock

Test cycle: Acceleration 25g at 6msec pulse width
 1000 cycles pos. 1000cycles neg.; 1Shock/s; 3 axis: X, Y, Z

Non Operational Vibration Test

Test cycle: Sinus 10 ... 300Hz; Elongation 0.25mm / 0.25g; 5 cycles; 1 axis
 Frequency area A: 10 – 22.28Hz, amplitude in A:0.25 mm
 Frequency area B: 22.28 - 300Hz, acceleration in B: 0.25g
 Sweep speed: 1 Octave/min, Cycles: 10
 Time per Sweep: 4.9 min

Non Operational Vibration Test

Test cycle: Sinus 10 ... 500Hz; Elongation 3.0mm / 1.5g; 5 cycles; 1 axis
 Frequency area A: 10 – 15.76Hz, Amplitude in A: 3.0mm
 Frequency area B: 15.76 - 500Hz, Acceleration in B: 1.5 g
 Sweep speed: 1 Octave/min, Number of sweeps: 10
 Time per Sweep: 5.62 min

5. Package mechanical data

5.1 Package outline

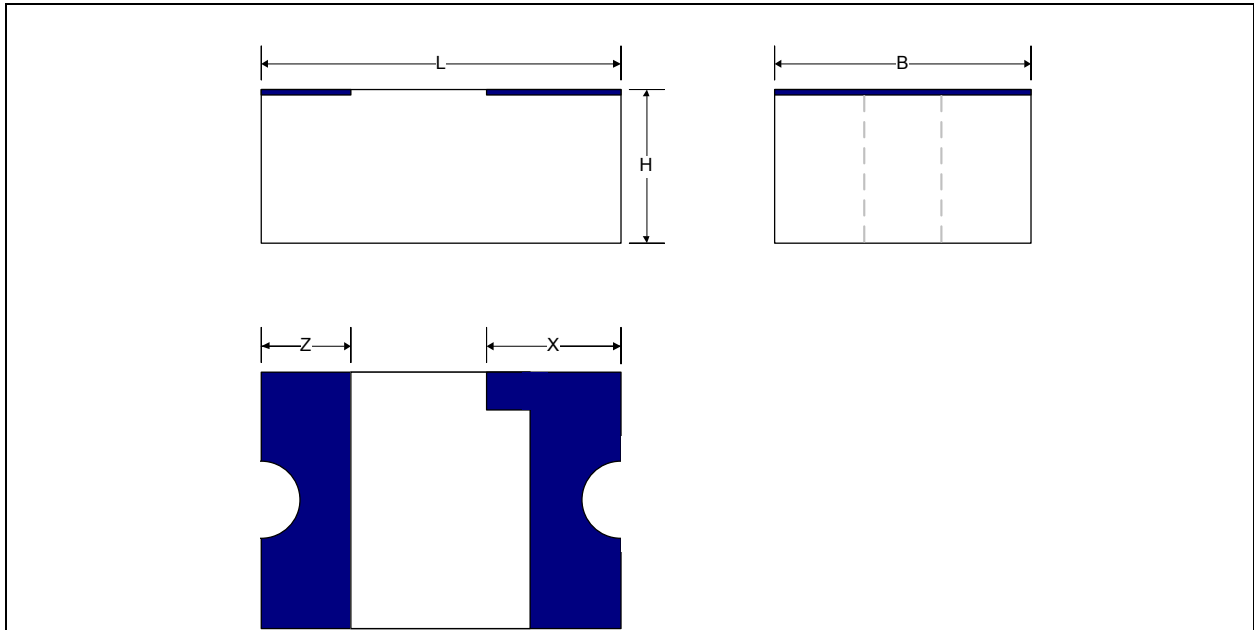

Figure 2: Package outline (drawing not to scale)

DIMENSIONS (mm)

Symbol	Value (mm)	Tolerance
L	2.850	±0.125
H	1.700	±0.125
B	2.450	±0.125
Z	0.675	±0.125
X*	1.055	±0.125

*Depending on the sensor orientation in the SMD belt or in the tray, the flag can be on the right or left side.

5.2 Footprint

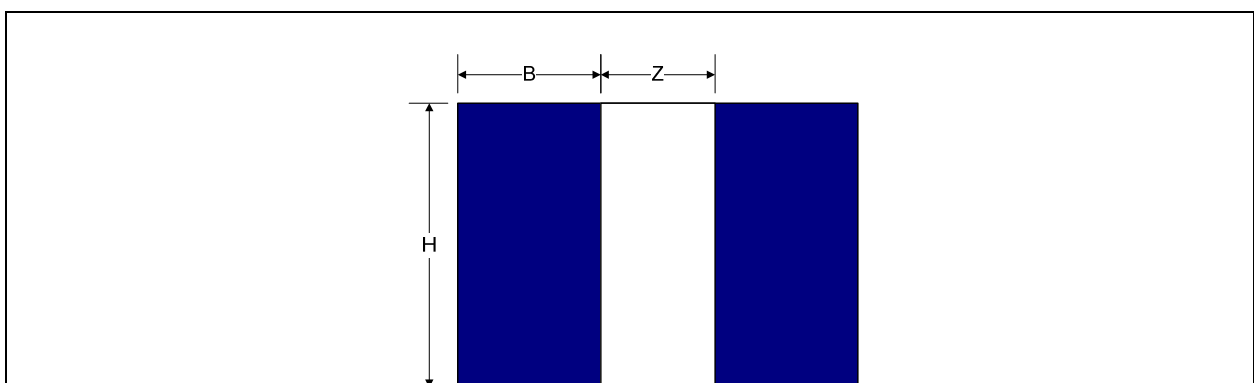

Figure 3: Recommended footprint (drawing not to scale)

DIMENSIONS (mm)

Symbol	Value (mm)
H	2.80
B	1.40
Z	1.00

6. Ordering information

6.1 Tape and reel (standard-packing)

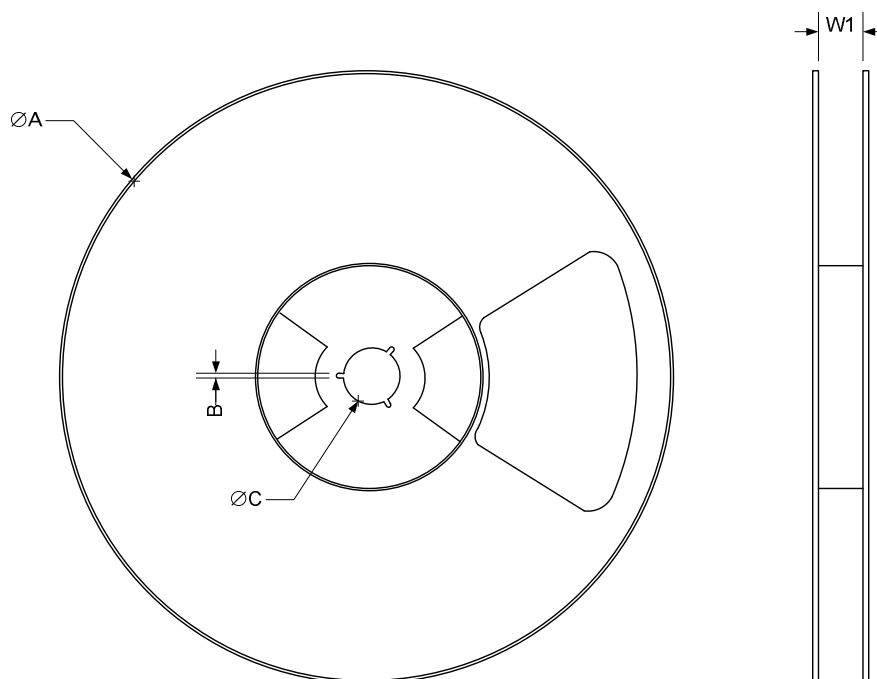

Figure 4: Reel information (drawing not to scale)

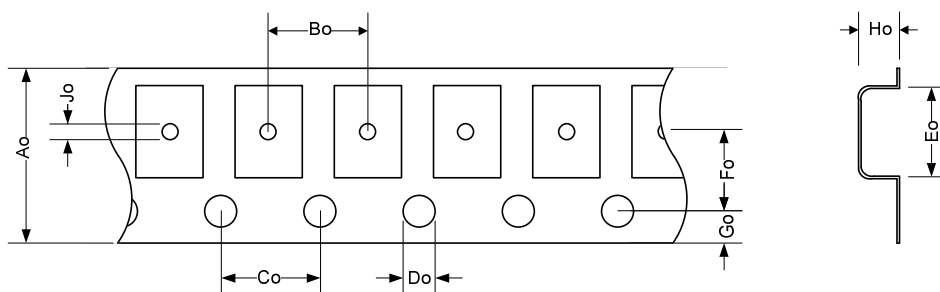

Figure 5: Tape information (drawing not to scale)

DIMENSIONS (mm)

Symbol	Min	Max
ØA	179.50	180.50
B	2.00	2.50
ØC	8.40	9.90
W1	8.40	9.90
Ao	7.70	8.30
Bo	3.90	4.10
Co	3.90	4.10
Do	1.40	1.60
Jo	0.80	1.20
Go	1.74	1.76
Fo	3.45	3.55
Eo	3.50	3.70
Ho	1.90	2.10

6.2 Tray (special-packing)

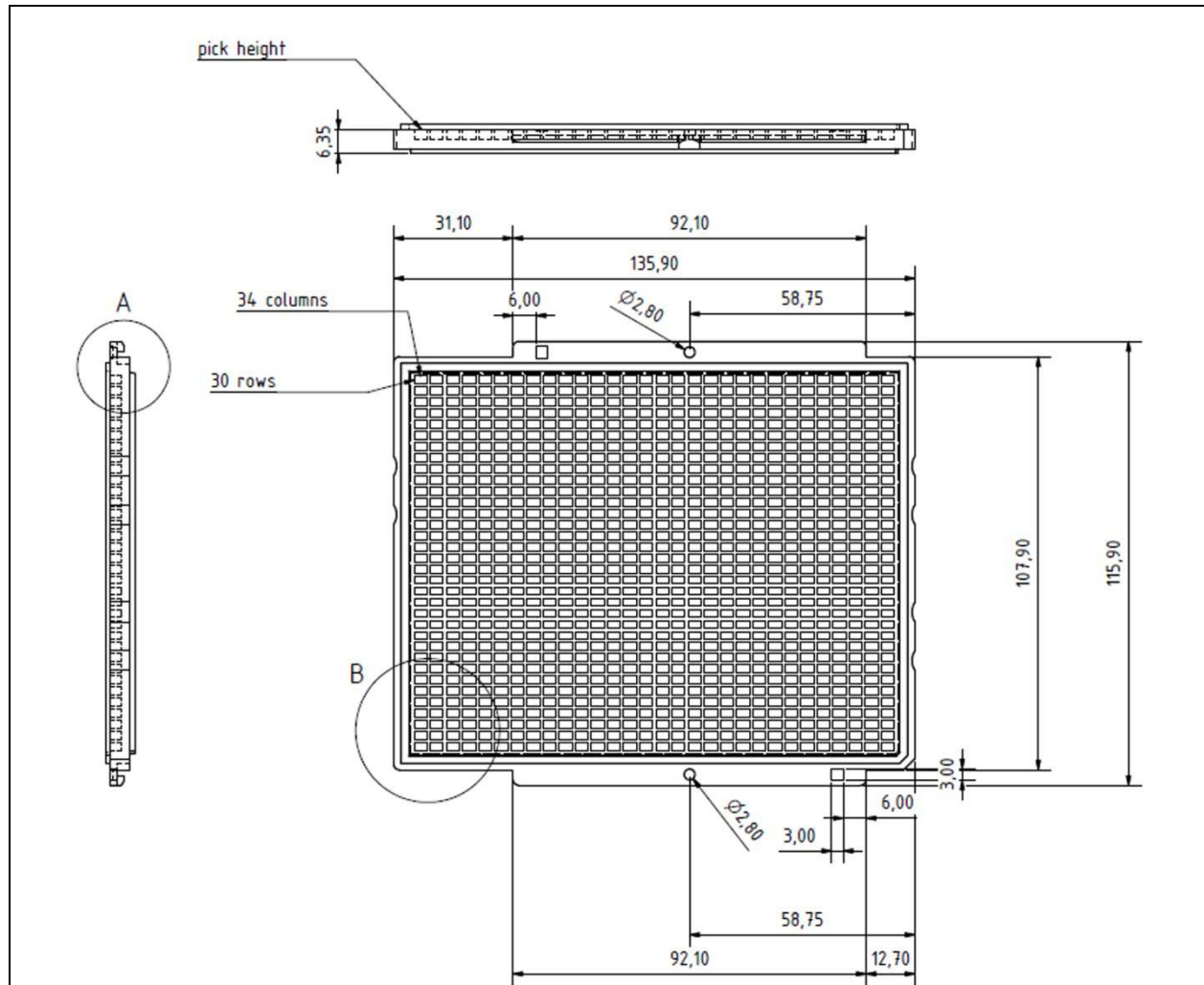

Figure 6: Tray (drawing not to scale)

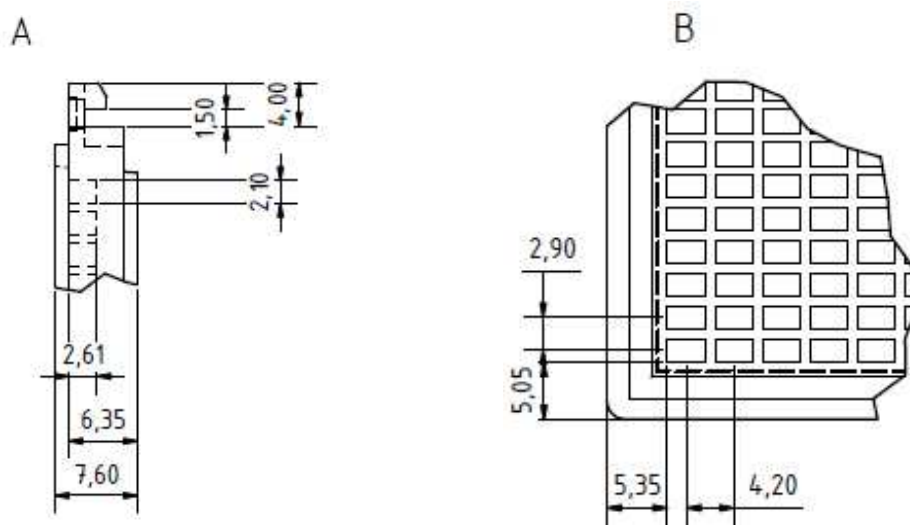

Figure 7: Detail view (drawing not to scale)

7. Important Notice

Sensolute GmbH reserves the right to make corrections, modifications, enhancements, improvements, and other changes to its products and services at any time. Customers should obtain the latest relevant information before placing orders and should verify that such information is current and complete.

Information furnished by Sensolute GmbH is believed to be accurate and reliable. However, this document may contain errors and omissions.

Sensolute GmbH assumes no liability for applications assistance or customer product design. Customers are responsible for their products and applications using Sensolute GmbH components. Accordingly, the design engineer should use this document as a reference rather than a strict design guideline and should perform thorough testing of any product that incorporates this or any other Sensolute GmbH product.

Sensolute GmbH products are not authorized for use in safety-critical applications (such as life support) where a failure of the sensors would reasonably be expected to cause severe personal injury or death, unless officers of the parties have executed an agreement specifically governing such use.

No license is granted by implication or otherwise under any patent or patent rights of Sensolute GmbH. Trademarks and registered trademarks are the property of their respective companies.

On the following URL you can obtain information on other Sensolute GmbH products and application solutions:

www.sensolute.com

Mailing Address:

Sensolute GmbH
Hermann-von-Helmholtz-Platz 1
76344 Eggenstein-Leopoldshafen, Germany